

Coax Velocity Factor in Baluns, Does it Matter?

©John Huggins

9 August 2010

Numerous folks use baluns for their antenna feedpoints. Toroid chokes are wideband and popular in the HF frequencies.

VHF and UHF antennas, especially beams, often have balanced feed points. Several methods exist to connect unbalanced coax to the dipole element: gamma, t-match, etc. Some VHF/UHF Balun options use tuned stub or shunt topologies to achieve the unbalanced to balanced goal; Methods include the Pawsey Stub, Split Coax Balun, Coaxial Cable Balun and Folded Balun to name a few. Each of these requires specific lengths of conductors based on multiples of 1/4 wavelength at the design frequency.

When calculating 1/4 wavelengths, however, it seems the amateur radio community has lost the collective knowledge of when Velocity Factor (VF) of Coaxial Cable Dielectric Material applies. Indeed despite the decades of college texts and ARRL Antenna books showing otherwise, the idea Velocity Factor always applies to coaxial cable length calculations when used as nothing more than a wire stub in a Balun seems to have gone viral on the Internet.

The web site of G0KSC provides innovative new approaches to Yagi-Uda design. The author provides focus on the topic of Baluns on his Creating a Balun web page.

The topic of Baluns is vast so let's just focus on the ones for VHF/UHF antennas. Often these are tuned assemblies using some combination of coax and/or wire stubs of specific lengths.

G0KSC highlights several Baluns on his web page:

1:1 Coaxial Cable Balun I have never seen before using 1/4 and 3/4 wavelengths of coax. This is similar to the 4:1 Balun we have seen for decades in the literature.

1:1 Pawsey Stub - a method using a 1/4 wavelength wire off the coax center conductor and tied a 1/4 wavelength back.

One comment made on the web site concerns velocity factor of coax. Certainly the Coaxial Cable Balun has this effect which requires shortening wavelength dependent coax pieces. The author also claims the Pawsey Stub requires the same adjustment for velocity factor. The electric and magnetic fields for the Pawsey Stub are outside the realm of the coaxial cable dielectric suggesting this is not the case.

I decided to research the literature and build working models of both to see for myself which Balun requires Velocity Factor correction.

First let's examine the two Balun approaches and see what the literature suggests.

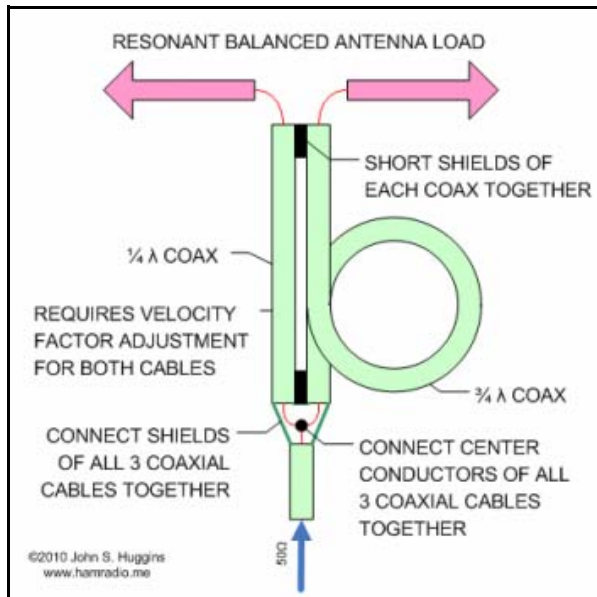

Fig 1 - 1:1 RF Balun using 1/4 and 3/4 wave coaxial cables

1:1 Coaxial Cable Balun

Figure 1 shows the pieces of this Balun...

This topology is brilliantly simple. A description can be found at IOQM's web site PDF file[1].

Folded Balun (aka Pawsey Stub) and 1/4 Wave Coaxial Balun

Figure 2 shows the idea behind the Pawsey stub which is known in Electrical Engineering circles as a variant of the Folded Balun[2].

While the Gray conductor in Figure 2 only needs to be a wire of similar size to the coaxial cable feedline, it is often made from a scrap piece of the same cable. Each end of the outer shield of the stub is connected to the feed system. A common thought of many is since this is coaxial cable, we need velocity factor adjustments. Since the electric and magnetic fields (of the stub system) are in air, I think velocity factor does not apply.

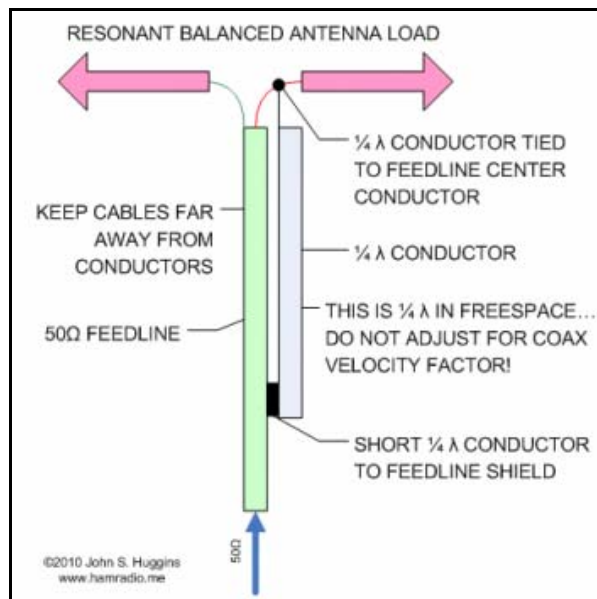

Fig 2 - Folded Balun (aka Pawsey Stub)

Figure 3 highlights my reasoning...

Fig 3 - Electric and Magnetic fields in dielectric materials define when velocity factor applies.

Fig 3 - Electric and Magnetic fields in dielectric materials define when velocity factor applies.

Figure 3a shows the construction of coaxial cable we are all familiar with. In normal operation all electric and most of the magnetic fields are contained between the inner and outer conductors. Since the spacing between these conductors is maintained by an insulating material, the fields are completely dependent on the dielectric constant of this material.

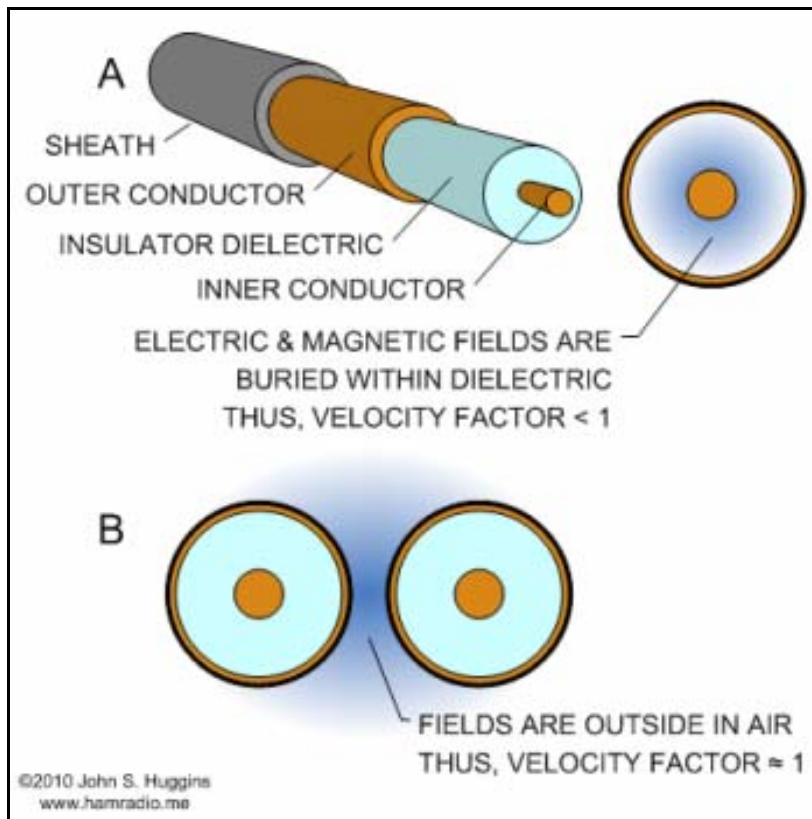

Fig 3 - Electric and Magnetic fields in dielectric materials define when velocity factor applies.

Figure 3b shows the same coaxial cable, but this time there are two pieces side by side as used in the Folded Balun. This balun, essentially a parallel transmission line, develops all its fields between the outer skin of the cables' shields, not within. The stub wire, as used in the Pawsey Stub method, could be a copper wire with the same effect.

The studious reader will notice the external fields are not entirely in free air. The cable jacket certainly has a dielectric constant greater than 1 and, as thin as it is, will retard the speed of light a bit. The effect is much less than the situation inside coax, however. So... the VF of free air is not quite 1, but almost is... about 0.90 to 0.98 or so.

UPDATE Oct 2010:

Measurements made on a variety of Folded Balun test samples reveal the Velocity Factor actually varies from 0.7 to over 1 depending on cable type and spacing. None matched the Velocity Factor caused by the dielectric inside the coax. The spacing between the two conductors had an enormous impact on the final tuning point. The range of values was a surprise to this author. Details on these tests will be available in an upcoming post.

Other Views

Balanis discusses the theory behind matching techniques including the 1/4 Wave Coaxial 1:1 Balun. In particular he describes the purpose of the electrical short of the coax center conductor to shield, is to maintain balance, thereby,

ensuring no current flows back to the transceiver on the outside of the coax. Interestingly, he notes...

"The parallel auxiliary line need not be made 1/4 wave in length to achieve the balance. It is made 1/4 wave to prevent the upsetting of the normal operation of the antenna."[3]

The above point suggests a stub with incorrectly calculated lengths effectively quells unbalanced feedline currents (good) while corrupting the balance in the antenna (bad). It appears easy to be lured into a false sense of security.

The Pawsey Stub approach is nothing new. For decades the Stub Balun has been described in the various editions of the ARRL Antenna Book. The 21st edition describes a Sleeve Balun and the Stub Balun and suggests each is to be 1/4 wavelength. It does not mention anything about velocity factor corrections leaving the reader to wonder.[4]

Go back in time and we find the 13th edition of the ARRL Antenna Book says this about the stub approach...

"In either case, the length of the detuning element is a full quarter wavelength; the propagation factor of the line does not enter into the picture here."[5]

Yet another view is noted by Roberts while describing his Wide-Band Balun named for him[6] stating about how long to make the parallel sections of coax thus...

"The length of the parallel section, measured from the point [. . .] where the two braids are connected together, to the points [. . .] where the balanced circuit is to be connected, is made one-quarter wavelength at the center frequency of the operating range. For the determination of this length, it is necessary to take account of the propagation velocity, which is somewhat higher than that of the waves moving along the inside of the coaxial cables."[6]

Roberts recognized the fields of the parallel portion of his design are in a mix of free air and sheath dielectric. He goes on...

"Because of variations in composition, diameter, or eccentricity of the outer insulation, the characteristics of parallel lines formed from certain coaxial cable samples may differ appreciably from the desired value. It is generally necessary, therefore, to determine the characteristic impedance and velocity of propagation by testing sample parallel line sections made of the intended material."[6]

Heeding Roberts' warning and evaluating the other evidence above, I assert the published values of velocity factor of coaxial cable should not be used for stub length calculations for stubs with fields outside the cable's interior.

Am I right? Let's quit guessing and test it!

Part 2 of this series highlights the actual test I performed to prove I am correct.

Coax Velocity Factor in Baluns, Does it Matter? Part 2

In the previous post I discuss various attributes concerning the use of Baluns especially in the VHF/UHF bands. I point out other web sites with excellent tutorials on why and where to use Baluns in VHF work. Two particular Balun styles come up strong: 1:1 Coaxial Cable Balun and the Pawsey Stub otherwise known as 1:1 Folded Balun. Each Balun's topologies are shown in Figures 1 and 2. I highlight the mistaken, I believe, assertion one should adjust the Pawsey Stub's length by the amount of the coaxial cable velocity factor. Figure 3 shows why I think the Pawsey Stub length does not need as drastic a reduction in length as you might do for stubs that contain the electric and magnetic fields within their structure. Finally, I say I will prove my assertion the Pawsey Stub is electrically a 1/4 wave in free space or close.

What follows is the experiment which provides proof Velocity Factor of Coaxial Cables does not apply to cables used simply as a wire in parallel with another wire.

The Experiment

The two Baluns are an excellent pair to compare. The Coaxial Cable Balun is just two transmission lines tied together one 1/4 wavelength long, the other 3/4 wavelength long. In this case the electric and magnetic fields are entirely within the dielectric material. Thus the velocity factor adjustment should apply. The Pawsey Stub relies entirely on becoming a parallel transmission line with the feedline coax. Its fields are entirely outside the structure of the coax.

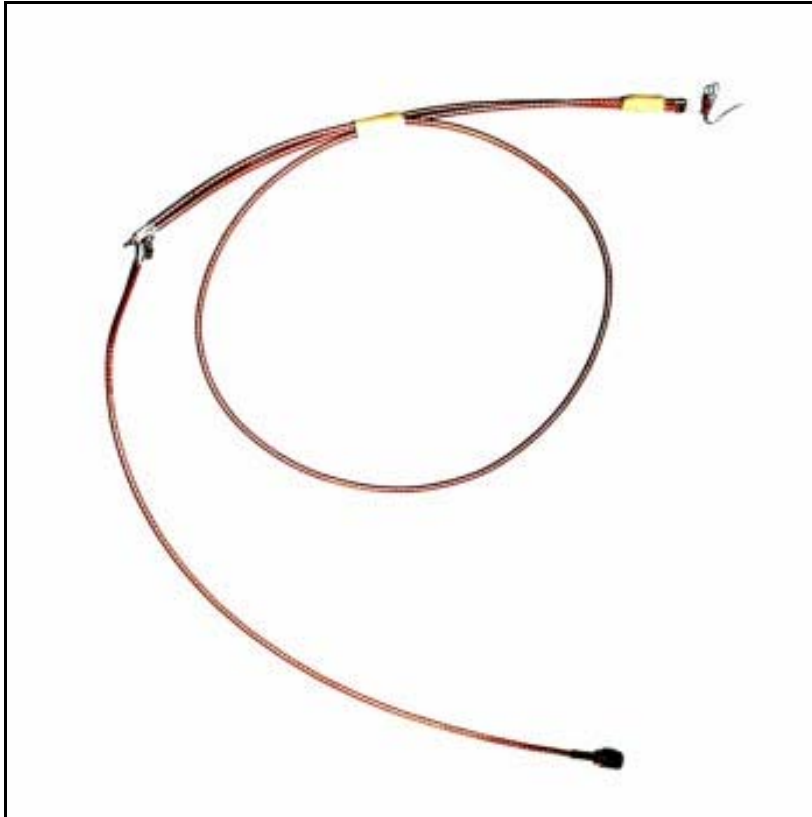

Fig 4 - Coaxial Cable Balun with 1/4 and 3/4 sections of coax, cut for 300MHz Freespace, in parallel.

I built the two baluns using some RG316 coax. My target frequency for both is 300 MHz. I cut pieces with no corrections applied to see how the frequency changes.

The Coaxial Cable Balun has the following dimensions based on calculations..

- 1/4 wave section = $300\text{m/s} / 300 \text{ MHz} * .25 = 25\text{cm} \sim 9.8 \text{ inches}$
- 3/4 wave section = $300\text{m/s} / 300 \text{ MHz} * .75 = 75\text{cm} \sim 29.5 \text{ inches}$

I simply cut two pieces of coax to the above lengths and added a third with an SMA connector for the feed line.

Figure 4 shows the

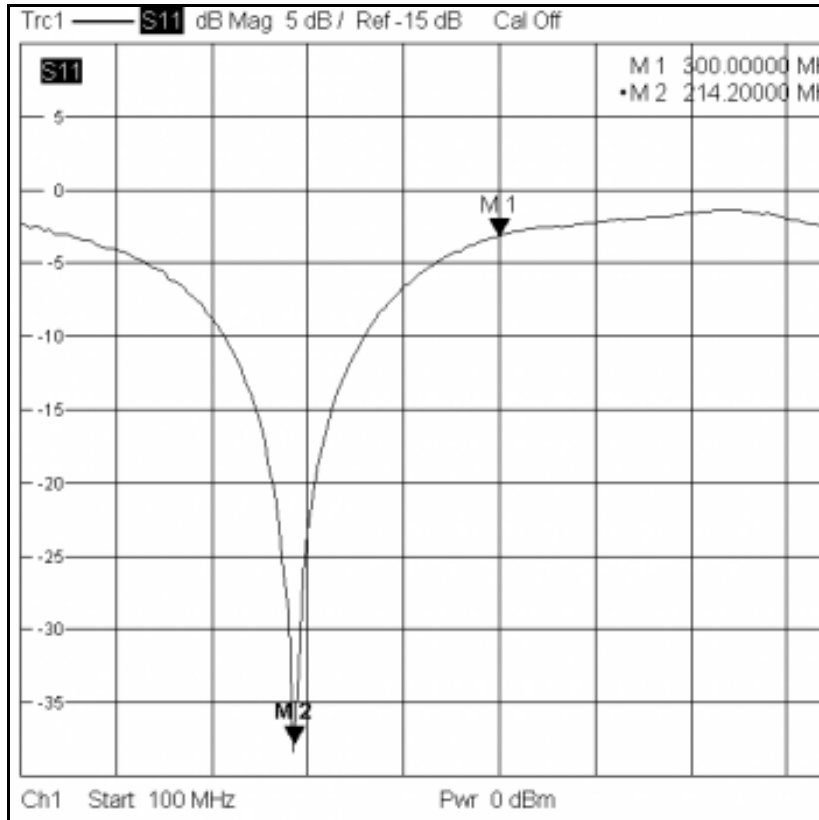

Fig 5 - Return Loss of Coaxial Cable Balun from 100 - 500 MHz. Markers M1 and M2 are at 300 and 214 MHz respectively.

Coaxial Cable Balun with a 50 ohm resistance at the balanced feed point.

With the resistance at the feedpoint, the Balun should show some very obvious frequency dependence on a Return Loss or SWR plot. Because this is the case where Velocity factor does apply, the target frequency of 300 MHz should be lowered by .695 or about 208 MHz. Given that I flayed the coax shield and center, thereby reducing some of the coaxial cable length, the actual frequency should be a little higher.

Figure 5 shows what happens when I connect the Coaxial Cable Balun to the VNA...

Wow! The 214 MHz pretty much confirms that Velocity Factor is well in play for this style

of Balun.

Now let's try the Pawsey Stub. The only critical dimension is the stub length.

$$1/4 \text{ wave section} = 300\text{m/s} / 300 \text{ MHz} * .25 = 25\text{cm} \sim 9.8 \text{ inches}$$

Once again, my trimming slightly shortens the actual electrical length to about 9.2 inches which raises the frequency just a bit. Figure 6 shows my test unit with 50 ohms at the feed point.

What's the prediction here? If you listen to the web sites which suggest coax cable VF applies, the frequency will be between 210 and 230 MHz. If I am right and this is free space, or very close to free space, then the frequency should be about 300 MHz, or since the connection points on the stub are a little closer together, something a bit higher. Let's see the Return Loss plot...

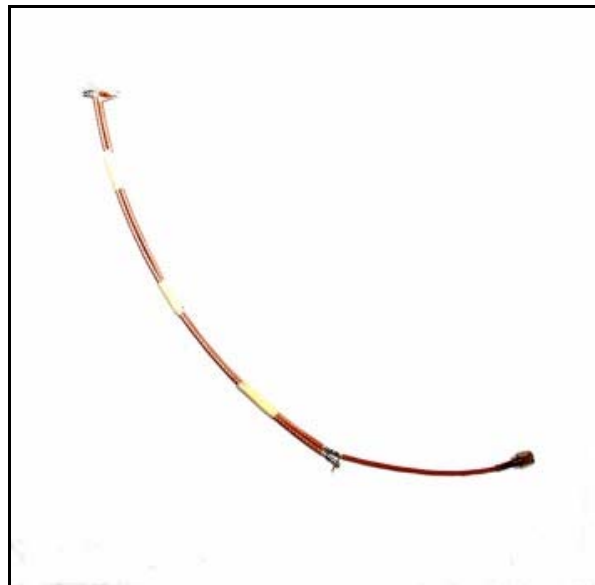

Fig 6 - Pawsey Stub Balun with 1/4 of coax, cut for 300MHz Freespace, in alongside the feedline.

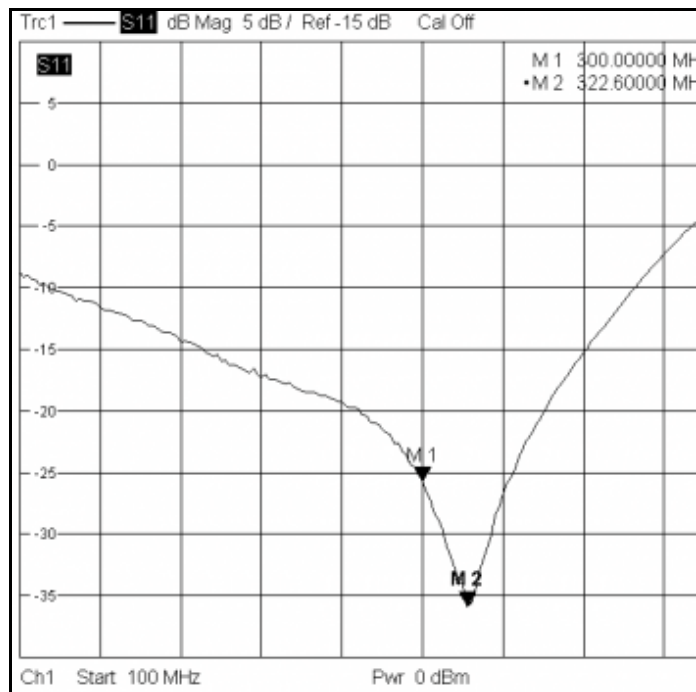

Fig 7 - Return Loss of Folded Balun from 100 - 500 MHz. Markers M1 and M2 are at 300 and 322 MHz respectively.

Bulls Eye!!!!

This strongly suggests the lengths of external stubs, like the Pawsey Stub (or any Folded Balun variant), should be calculated using free space wavelengths without corrections for Velocity Factor.

The funny thing is, this has been the case in the ARRL Antenna book for many many years. The later editions never suggest to apply velocity factor to external stub calculations and the 13th edition specifically says VF does not apply.

Interference from Nearby Objects - an Additional Observation
Testing of the above two Baluns revealed an interesting behavior. The 1:1 Coaxial Cable Balun was immune to effects from handling during the test. The Pawsey Stub was very sensitive to touch or even being close to

the stub portion. This evidence correlates well with the measurements suggesting the Pawsey Stub's electric and magnetic fields are, at least some if not entirely, outside the realm of any dielectric material.

Conclusion

It is a good thing Amateur Radio Operators know about transmission line Velocity Factor specifications. Without this knowledge you would be cutting stubs incorrectly. However, some Amateurs assume that just because a piece of coax is used for a stub, Velocity Factor applies. The key to understanding when it does and when it doesn't is found by following the electric and magnetic fields. Where are they? Are they inside the coax or outside between pieces of coax? If inside, apply VF. If outside assume freespace.

Measure, but verify...

This experiment relies on some crude cutting of cable lengths and assumed values of Velocity Factor. Potential sources of error include:

- Cable End Trimming - Source for my slight errors above
- Coax Velocity Factor not what the manufacturer says - When you do need to know VF, it might be a bit off especially with lower quality coax
- Freespace not quite freespace - Even the best air gap transmission line has some dielectric material in the fields - VF values of 0.95 are common even with parallel transmission ladder line.

So what does this suggest? If you are going to the trouble to make something as critical as a Balun for your Yagi antenna, electrically measure each cable with your SWR meter or VNA to ensure you are spot on the frequency of choice.

This was an interesting test. I am now so interested in Baluns, I will focus on posts for each type in the near future.

Thanks for reading.

John

References:

- I0QM. "Coaxial Balun by I0QM."
http://www.iw5edi.com/ham-radio/files/I0QM_BALUN.PDF, 2001.
- Milligan, Thomas. Modern Antenna Design. McGraw-Hill, Inc., 1985, pp. 74-77.
- Balanis, Constantine. Antenna Theory - Analysis and Design. John Wiley & Sons, Inc., 1982, pp. 365-368.
- R. Dean Straw et al. "Baluns and Antenna Tuners." ARRL Antenna Book. The ARRL, Inc. 21st ed. 2007. pp 18.6-18.7.
- Gerald L. Hall et al. "Using Coaxial Lines" ARRL Antenna Book. The American Radio Relay League, Inc. 13th ed. 1974. pp 229-230.
- Proceedings of the IRE, "A New Wide-Band Balun," Proceedings of the IRE, Volume 45, Issue 12, December 1957, pp 1628-1631

This fine article was posted to a website at <http://tinyurl.com/7out6f9>

I have captured it and reformatted to a single .pdf file here for the edification of AeroElectric Connection readers. My sincere thanks to John Huggins for sharing his scholarly effort and insight on this topic with the world community. John's attitude for "let's go to the bench and test it" is in keeping with the finest traditions for exploring, identifying and teaching of simple-ideas. BN

Coax Velocity Factor in Baluns, Does it Matter? The references at the bottom of the article provide some good quotes to consider. There are two things to consider for your question: why and where the split balun is shorted back together. In particular he describes the purpose of the electrical short of the coax center conductor to shield, is to maintain balance, thereby, ensuring no current flows back to the transceiver on the outside of the coax. As both halves of the split balun are fed by energy at the feedpoint 180 degrees out of phase, when the currents join at the shorted end, they are in balance and just act like a short between each other with little eagerness to flow current to the third conductor (the mast or feed system). Insulation does not matter for such a short run but technically it changes the velocity factor don't worry about it. I left the insulation on some of my antenna elements no reason just lazy. This is my semi final config with balun bolted direct to the antenna, coaxial jumper to amp. Shorts in Baluns: The only Baluns I've seen that intentionally have a DC-Short between the 75-ohm connections (coax to center wire) are the Channel Master and the similar Philmore MT74 (I found at Fry's Electronics). [I bought a pair of MT74's but never got around to doing an Insertion Loss test.....] Test results of the Coaxial Cable Balun and the Folded Balun (aka Pawsey Stub) reveal coax Velocity Factor applies to the former, but not the latter, unlike what many web sites would have you believe. Part 2 of 2. What follows is the experiment which provides proof Velocity Factor of Coaxial Cables does not apply to cables used simply as a wire in parallel with another wire. Velocity Factor Balun Experiment. The two Baluns are an excellent pair to compare. The Coaxial Cable Balun is just two transmission lines tied together one 1/4 wavelength long, the other 3/4 wavelength long.